

374,6 (14 3/4) GRDP115

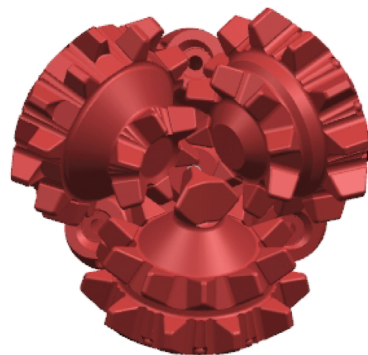

GrandPro bits are designed for multiple drilling of upper well sections (surface hole, conductor hole). The use of a sealed roller bearing, optimum cutting structure and leg body protection provides excellent bit life and superior performance. Applied for drilling in soft formations.

① SPECIFICATION

Diameter, mm (in)	374,6 (14 3/4)
IADC	115
Seal	O-Ring
Total number of inserts/teeth (inner/outer)	64 (35/29)
Total number of rows of inserts/teeth (inner/outer)	8 (5/3)
Number and diameter of nozzles*	4x15,9
Thread	Pin 7 5/8 Reg
Weight net/gross, kg	143 / 155,6

📦 PACKAGE DESIGN

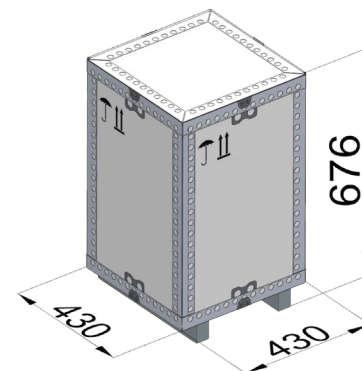

📋 DRILLING MODES RECOMMENDED**

Make-up torque, kN·m	46-54
RPM	280-40
WOB, t (lbs)	11,2-28 (25000-62000)

⚙️ DESIGN FEATURES



Sealed roller bearing with O-ring, rollers in large and small roller race. Provides high performance in a wide range of applications.



Tungsten carbide hardfacing aims to increase wear-resistance steel teeth bits. Both bulk and partial surfacing is used.



TCI on the cones gage are applied to calibrate the wellbore, protect cone body against erosion wear.



Additional heel row of TCI is designed to protect cone body against erosion wear and to increase contact area between the borehole and bit, to improve borehole quality.



To protect leg body and prevent bit wear, shirttail and leading edge are reinforced with TCI and additionally hardfaced.



Three side jets with additional central jet improves bottom hole cleaning, prevents cuttings re-grinding and bit balling.

* Standard specification may be changed on customer request.

** The specified ranges of WOB and RPM represent typical drilling modes, adherence to them will not necessarily result in optimal bit life or minimum drilling costs. It is not recommended to apply both WOB and RPM upper limits at once. For the purpose of performance improvement, minor changes of the bit design may be introduced without prior customer notification.